

CTC

CONNECTION TECHNOLOGY CENTER



SHORT FORM CATALOG



Who We Are

At CTC, we are a family-owned and operated business passionate about providing the best quality products backed by excellent customer service. We are the industry leader in quick delivery for stock and built-to-order products. All CTC products are proudly made or assembled in the U.S.A. We always honor our best-in-class warranties, and our customer service seeks to provide the best customer experience in the world.

What We Do

CTC is the world leader in the design and manufacture of industrial accelerometers, piezo velocity transducers, 4-20 mA vibration sensors, and proximity probes as well as all related mounting hardware, cabling, and junction boxes. Our products enable efficient vibration monitoring for predictive maintenance in a wide variety of industries. Industries served include cement, mining, petrochemical, food & beverage, auto, steel, wind, paper, power generation, water & wastewater treatment, pharmaceutical, hospitals, bottling, and more. Our mission is to offer the most extensive collection of accelerometers and vibration analysis hardware products, as well as the tools for installation. Our products are compatible with multiple third-party data collectors and online monitoring systems.



A handwritten signature in black ink that reads "Todd Cook".

**TODD
COOK**
Co-Owner



A handwritten signature in black ink that reads "Laura A. Cook".

**LAURA
COOK**
Co-Owner



A handwritten signature in black ink that reads "Andrew Cook".

**ANDREW
COOK**
Director of Sales



A handwritten signature in black ink that reads "Charlotte Cook".

**CHARLOTTE
COOK**
Director of Marketing

CONTENTS

CTC	4
New Product Announcements	4
Multipurpose Accelerometers.....	5
Ultrasound Sensor	6
High-Temperature Accelerometers	6
Wind Turbine Accelerometers	7
Underwater Accelerometers.....	7
Temperature & Vibration Sensors	8
Hazardous Rated Accelerometers.....	8
Triaxial Accelerometers.....	9
Cables.....	10
Connectors.....	11
Adapters & Accessories	13
Junction Boxes.....	15
Mounting Hardware	17
4-20 mA	20
Signal Conditioners	21
PRO	22
Proximity Probes.....	22
Wireless Monitoring Solutions	23



VIBRATION ANALYSIS HARDWARE



PROTECTION & RELIABILITY INSTRUMENTS

Product Offerings

At CTC, we offer two comprehensive product lines to meet your industrial vibration monitoring needs. Our products reflect the input from customers and distributors around the world and are designed and tested to meet the real-world demands of plant environments. We believe our products are the highest quality on the market, which is why we back each product line with our best-in-class warranties.



VIBRATION ANALYSIS HARDWARE

The CTC product line features vibration analysis hardware for heavy industry.

All CTC products are backed by our unconditional lifetime warranty. If any CTC product should ever fail, we will repair or replace it at no charge.



PROTECTION & RELIABILITY INSTRUMENTS

The PRO line offers complete proximity probe systems compatible with all standard condition monitoring software.

All PRO products are backed by a lifetime warranty on materials and workmanship. PRO will repair or replace any of our products as long as the product was not subjected to misuse, neglect, natural disasters, improper installation, or modification.

Refund Policy

All stock products qualify for a full refund if returned in new condition within 90 days of shipment. Built-to-order products qualify for a 50% refund if returned in original condition within 90 days of delivery. Custom products are quoted and built specifically to the requirements of the customer, which may include completely custom product designs or private-labeled versions of standard products for OEM customers. Custom products ordered are non-cancellable, non-returnable, and non-refundable.

Coming Soon to the CTC Family



SC300 Series Field Configurable Signal Conditioner

The SC300 signal conditioners are a powerful yet flexible tool for continuously monitoring critical equipment.

Two independent outputs, configurable to either 0-20 mA, 4-20 mA, 0-5V, or 0-10V; each with its own configurable scaling in reference to the input sensor

Ultrasound frequencies supported up to 40 kHz

Field configurable via external USB port to PC with free CTC configuration software

TXFA330 Series Low Frequency Triaxial Accelerometer

500 mV/g

Side exit

Designed for Low Speed Rotors, Main Bearings, and Gear box inputs



TCEB330 Series Miniature Industrial Circular Triaxial Accelerometer

100 mV/g

Top exit

Compact, circular case creates an ergonomic design for portable measurements



Backed by our Unconditional Lifetime Warranty!

CTC offers a complete line of industrial accelerometers. Our ruggedized industrial accelerometers are available in single axis, biaxial, and triaxial designs. Many configurations allow for either top or side exit options. Side exit configurations are suitable for installations in areas where height is an issue. CTC's industrial accelerometers support a diverse set of applications with sensitivity values ranging from 10 mV/g to 1000 mV/g. Dual output configurations allow for vibration and temperature outputs.

Multipurpose Accelerometer, Top Exit



STANDARD SIZE



COMPACT SIZE



MINI SIZE

Multipurpose Accelerometer, Side Exit



STANDARD SIZE



COMPACT SIZE



MINI SIZE



Backed by our Unconditional Lifetime Warranty!

ACCELEROMETERS

Multipurpose Accelerometer, Integral Cable Options



STANDARD INTEGRAL



ARMORED INTEGRAL

ULTRASOUND



Sensitivity: 100 mV/g
Resonant Peak: 44 kHz

Ultrasound Sensor

UEB330

High frequency ultrasound sensor with high amplitude resonance peak for stress wave measurement techniques and IEPE amplifier technology.

HIGH-TEMPERATURE

High-Temperature Accelerometers



AC207
100 mV/g
Max Temp: 325° F (162° C)



AC208
100 mV/g
Max Temp: 325° F (162° C)



CM362-7A
50, 100 mV/g
100 mV/in/sec
Max Temp: 650° F (343° C)



Backed by our Unconditional Lifetime Warranty!

Power generation is a critical need in today's world. Uptime is the primary concern, and to maintain power generation, the machines need to be running. CTC's goal is to improve reliability with permanently mounted accelerometers to monitor wind turbine vibration and provide early detection for potential failure. CTC has multiple options to fit your specific application. Low-frequency accelerometers are ideal for main bearing and other slow-speed applications. Our multipurpose accelerometers are best suited for gearboxes and generators.

Accelerometers for Wind Turbine Applications

WT135

Low frequency wind turbine accelerometer 500 mV/g



WT136

Low frequency wind turbine accelerometer 500 mV/g



MOLDED ACCELEROMETERS

Underwater Accelerometers
featuring a fully molded design



MCB211

High frequency 10 mV/g



MDB211

High frequency 50 mV/g



MEB210

General purpose 100 mV/g



MEB211

High frequency 100 mV/g



MEB212

5 kVAC protection 100 mV/g 10 ft integral cable



SUGGESTED MOUNTING HARDWARE

MH154-1B

Flat surface pull strength: 15lbs/7kg



Backed by our Unconditional Lifetime Warranty!

TEMPERATURE & VIBRATION

Dual Output Temperature and Vibration Sensors



TA202
100 mV/g
10 mV/°C
Temp Range:
-40 °F to 250 °F



TA204
100 mV/g
10 mV/°C
Temp Range:
-40 °F to 250 °F



TR102-M12A
100 mV/g
PT100 RTD
Temp Range:
-40 °F to 250 °F



TR104-M12A
100 mV/g/axis
PT100 RTD
Temp Range:
-40 °F to 250 °F

HAZARDOUS RATED

Hazardous Rated Accelerometers

CTC offers a variety of single axis, biaxial, triaxial, dual output, and low capacitance sensors certified for Class I Division 2 (ATEX/IECEX Zone 2), as well as intrinsically safe protection methods under Class 1 Division 1 (ATEX/IECEX Zone 0/1).

Hazardous Ratings

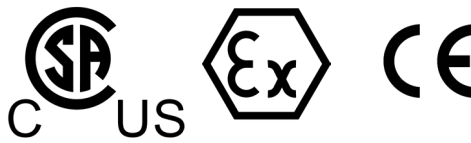

CLASS I DIVISION 1
ATEX/IECEX ZONE 0, 1



CLASS I DIVISION 2
ATEX/IECEX ZONE 2



Backed by our Unconditional Lifetime Warranty!

TREA330 Compact Triaxial Accelerometers



SIDE EXIT
100 mV/g



INTEGRAL
100 mV/g



ARMORED INTEGRAL
100 mV/g

Other Popular Triaxial Accelerometers



AC115
Low cost 4 pin
100 mV/g



AC119
Biaxial with X & Z axis
100 mV/g



AC155
Low cost 4 pin
Modal/ODS
100 mV/g



AC230
Premium 4 pin
100 mV/g



AC360
Modal/ODS
100 mV/g



AC365
Modal/ODS
100 mV/g



TRCA330
Compact 4 pin
10 mV/g



Backed by our Unconditional Lifetime Warranty!

CTC Offers a Variety of Cable Options for All Application and Environmental Criteria

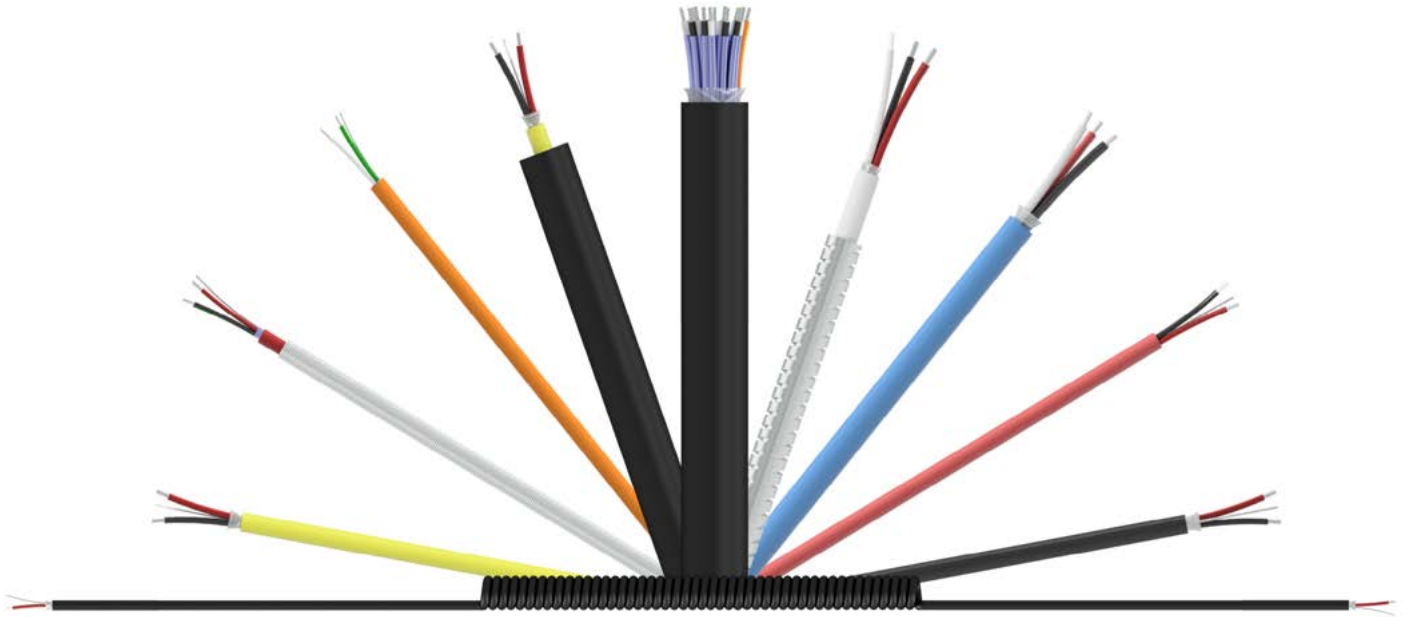

JACKET TYPES

- Fluorinated ethylene propylene (FEP)
- Polyurethane
- Lightweight Polyurethane
- PVC
- Thermoplastic Elastomer (TPE)
- Low Smoke Zero Halogen

ARMOR OPTIONS

- Stainless Steel Braided Sheathing
- Stainless Steel Armor
- Hydraulic Hose Armor

CONDUCTOR OPTIONS

- 2 Conductor
- 3 Conductor
- 4 Conductor
- 6 Conductor
- 8 Pair Multi Conductor
- 12 Pair Multi Conductor
- 16 Pair Multi Conductor
- 12 Triad Multi Conductor

HAZARDOUS ZONE OPTIONS

Class 1 Division 2 approved cables



Backed by our Unconditional Lifetime Warranty!

CTC Offers a Variety of Standard and Specialty Connectors for Every Possible Application

CTC sensor connectors support temperatures ranging from -58 ° F to 325 ° F (-58 °C to 163 °C). A wide selection of connectors supporting IP (Ingress Protection) ranging from IP66 to IP68 is available.

A SERIES: 2 OR 3 SOCKET MIL STYLE (C-5015) COMPATIBLE CONNECTOR



Connector options

- Standard
- Right angle
- Hydraulic hose

Material options

- Polycarbonate
- Polyurethane
- Nylon
- Polyphenylene sulfide (PPS)

D SERIES: 2 OR 3 SOCKET MIL STYLE (C-5015) COMPATIBLE CONNECTOR



Connector options

- Standard
- Grounded to sensor case
- Right angle
- Backshell
- Backshell for Class 1 Division 2
- Molded strain relief
- Bending strain relief

Material options

- Polyurethane

J SERIES: 2 OR 4 SOCKET MINI-MIL CONNECTOR



Connector options

- Standard
- Strain relief
- Class 1 Division 2 rated

Material options

- Polycarbonate
- Nylon
- Polyurethane

M SERIES: 5 SOCKET M12 MOLDED CONNECTOR



Connector options

- Available in 2, 3, 4, and 5 live pin configurations

Material options

- Nylon
- Polycarbonate
- Polyurethane

V SERIES: VITON BOOT



Connector options

- Available in 2 or 3 live pin configurations

Material options

- Viton seal with
 - Nylon insert option
 - PPS insert option

Many other connector options are available. Please [visit our website](#) for more details.



Backed by our Unconditional Lifetime Warranty!

Data Collector Cord Sets

CTC offers a variety of OEM replacement data collector cables and portable cable options for all major vibration analyzer manufacturers. Data collector cables are available in both coiled and straight cable options. Replacement cable assembly and adapters are available for every major data collector including:

ACOEM, ADASH Ltd, GE/Commtest, Azima/DLI, Emerson/CSI, Erbesd, Pruftechnik, Rockwell/Entek, Schenck Trebel, SDT, SEMAPI, SKF, and SPM.

Popular Data Collector Connectors



**EMERSON/CSI
C555**

Channel A acceleration
input to CSI 2130 & 2140



**SKF
C66**

Channel A input for
CMXA50, 70, 75 & 80



**ACOEM
C494**

Single channel input for
Falcon data collectors



**PRUFTECHNIK
C618**

Single channel input to
VIBXpert II



**ROCKWELL/ENTEK
C22**

Single channel input for
dataPAC & enPAC



**GE/COMMTEST
C416**

Triaxial input X, Y and Z for
vb6 & vb8



Backed by our Unconditional Lifetime Warranty!

Popular Adapters

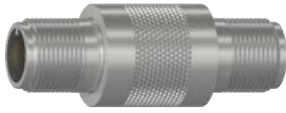

CB901-1A
2 pin MIL to 2 pin MIL
in-line feed thru



CB903-1A
2 pin MIL to 2 pin MIL
bulk head feed-thru,
1/2-NPT



CB908-1A
2 pin MIL to BNC plug
adapter with molded
reinforcement



CB910-1A
In-line BNC jack to
BNC jack adapter

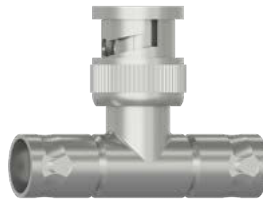

CB911-1A
BNC tee adapter



CB911-3A
In-line BNC plug to
BNC plug adapter



CB912-1A
2 socket MIL to BNC
plug adapter



CB917-1A
BNC jack feed-thru
connector with
mounting bracket



EMPP
BNC jack
measurement point
with protective cover



Backed by our Unconditional Lifetime Warranty!

Specialty Mounting Adapters & Studs

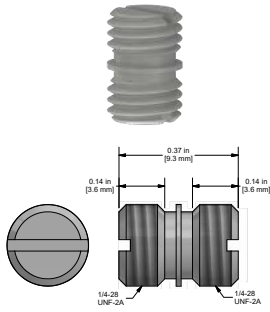

MH108-1B
1/4-28 to 1/4-28
mounting stud
stainless steel

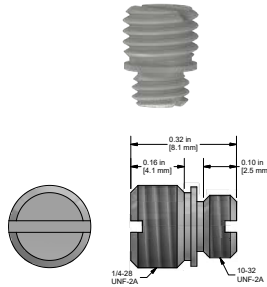

MH108-3B
1/4-28 to 10-32
adapter stud
stainless steel

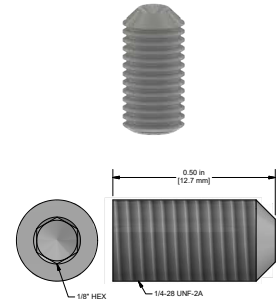

MH108-4B
1/4-28 set screw
1/2 in. length
stainless steel

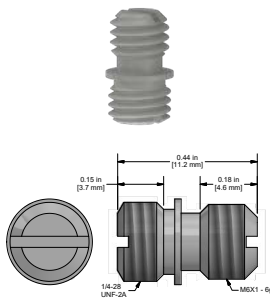

MH108-5B
1/4-28 to M6x1
adapter stud
stainless steel

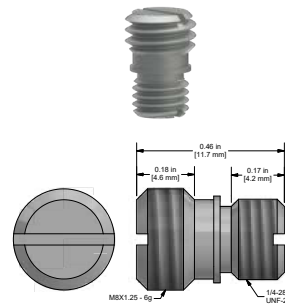

MH108-6B
1/4-28 to M8
adapter stud
stainless steel

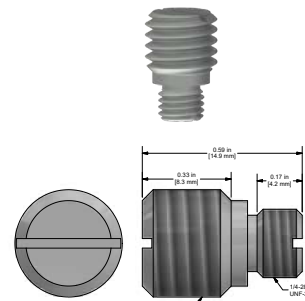

MH108-7B
1/4-28 to M10
adapter stud
stainless steel

Junction Box Accessories



JB903-1A
Cord grip for use with
cable diameter
0.118 in. - 0.256 in.



JB938-1A
1 in. rigid body
conduit fitting



JB938-2A
1/4 in. rigid body
conduit fitting



Backed by our Unconditional Lifetime Warranty!

At CTC, we offer the widest variety of junction boxes in the world. Our junction box solutions allow for the monitoring of remotely mounted vibration sensors, which would be otherwise restricted to human access due to safety considerations. Also offered is a selection of low-cost cable termination boxes that allow multiple measurement points to be routed to a single location to gather data. Many CTC junction boxes offer continuous output options for direct interface to online monitoring systems.

Premium JB Series Switch Boxes

Fully featured NEMA 4X (IP66) rated vibration junction box with IEPE sensor condition indicator lights and convenient interface with fold-forward panel for easy wiring.



JB100/JB200

Allows for up to 12 channels for single axis, biaxial, or triaxial outputs



JB100 - 24-48 Channel

Available in 24, 36, or 48 channels



JB300 SLOPE TOP

Available in 4, 6, 8, 10, or 12 channels

Legacy Switch Boxes



SB102/SB202

Fiberglass or stainless steel switch boxes available in 4, 6, 8, 10, or 12 channels



SB142/SB242

Fiberglass or stainless steel switch boxes for dual output available in 4, 6, or 8 channels



SSB-MODX

12 channel DIN rail mountable switch module subassembly



Backed by our Unconditional Lifetime Warranty!

Cable Termination and Enclosed BNC Connection Boxes



CT101

Cable termination boxes for up to 4 channels



MMX-MOD3

DIN rail mountable module for up to 3 channels



MX102/MX202

Fiberglass or stainless steel MAXX boxes available in 1-12 channels



MX502

Aluminum Mini-MAXX boxes available in up to 4 channels

Cable Reduction Boxes



CR102/CR202

Fiberglass or stainless steel cable reduction boxes for 8, 12, and 16 channels
-58 °F to 180 °F
(-50 °C to 82 °C)



CRHT102/CRHT202

Fiberglass or stainless steel high temperature (-40 °F to 212 °F / -40 °C to 100 °C) cable reduction boxes for 12 and 16 channels



Backed by our Unconditional Lifetime Warranty!

CTC offers a variety of adhesive and stud mounted sensor mounting pads. Magnet mounting pad options for portable field applications are also available, including flat and two rail mounting configurations. Additionally, we offer specialty mounting accessories for fin-cooled motors as well as a variety of extension adapters, which allow access to traditionally hard-to-reach bearing locations. Visit our website for a complete list of our mounting hardware solutions.

Rare Earth Magnetic Bases made from Neodymium Iron Boron

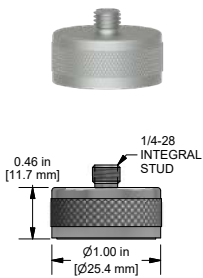

MH103-1B

Flat surface
pull strength:
40lbs/18kg

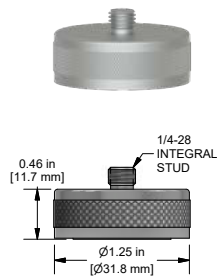

MH104-1B

Flat surface
pull strength:
60lbs/27kg

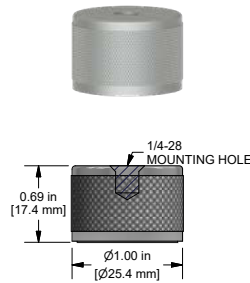

MH122-1A

Flat surface
pull strength:
40lbs/18kg



MH136-1A

Flat surface
pull strength:
25lbs/11kg

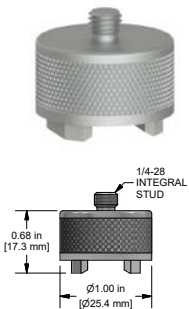

MH112-1A

Multipurpose
pull strength:
30lbs/14kg

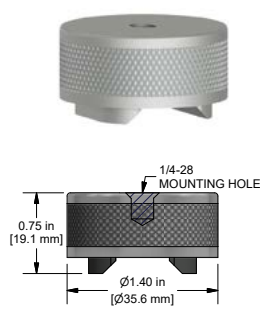

MH114-3A

Multipurpose
pull strength:
50lbs/23kg

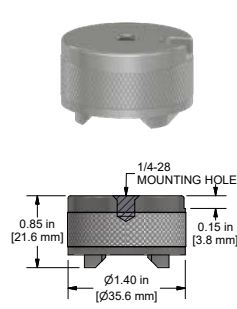

MH114-3T

Multipurpose
pull strength:
50lbs/23kg

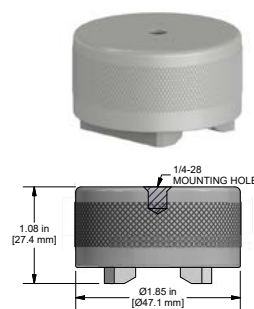

MH115-2A

Multipurpose
pull strength:
95lbs/43kg



Backed by our Unconditional Lifetime Warranty!

Accelerometer Quick Disconnects

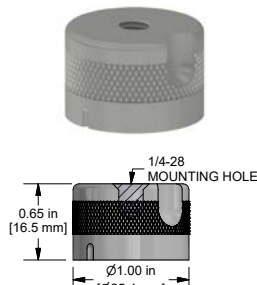

MH107-1A

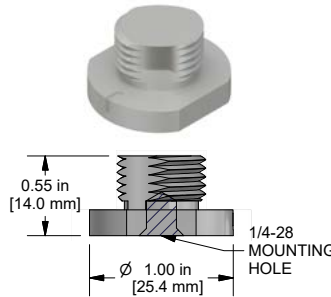

MH107-1B

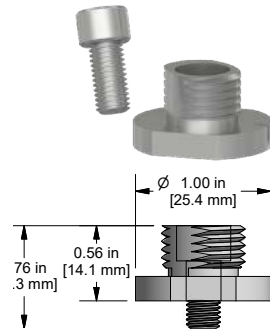

MH107-2B

Mounting Pads/Magnet Targets

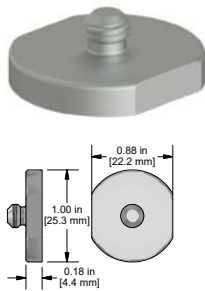

MH101-1B

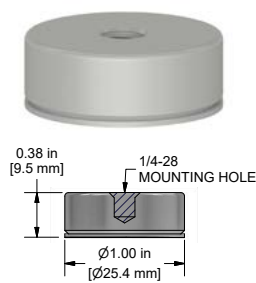

MH130-1A

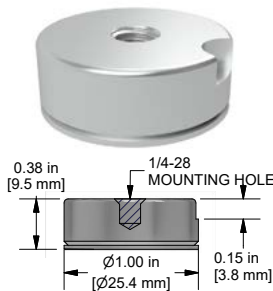

MH130-1T



MH133-1A

Zerk and Specialty Mounting Adapters

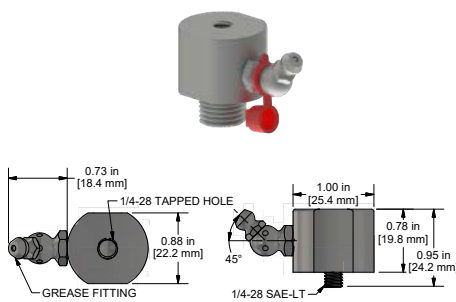

MH134

Zerk Adapter

Available mounting threads:
1/4 NPT, 1/8 NPT

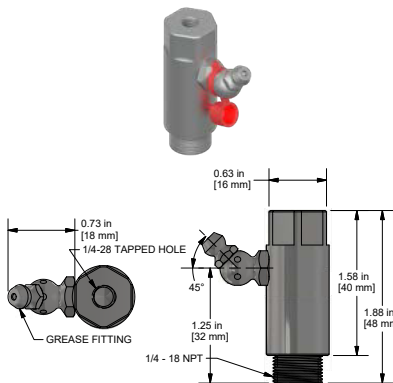

MH134-4B

Zerk Adapter

Available mounting threads:
1/4 NPT

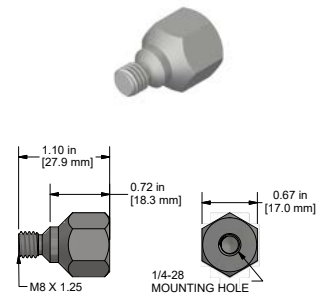

MH143-1A

Hex head mounting stud
for accelerometers

SPM Compatible



Backed by our Unconditional Lifetime Warranty!

Motor Fin Probe Pads

Take measurements from hard-to-reach places.

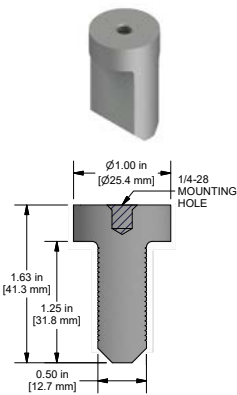

MH118-1A

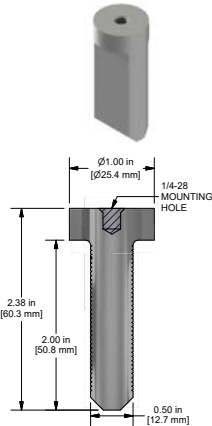

MH118-2A

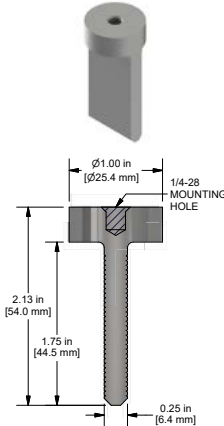

MH118-3A

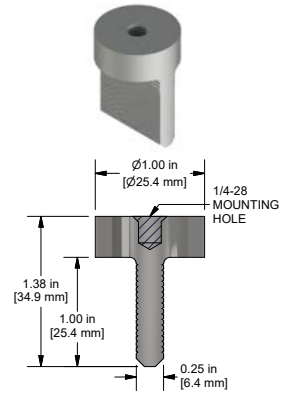

MH118-4A

Our fin mount probes are perfect for narrow measurement points in motors, turbines, and other machinery. Fin mounts can be used for portable route measurements or permanently mounted accelerometers.

Accelerometer Installation Tool Kit



MH117 SERIES

Spot face and pilot hole drill in one operation.
Option for taps and ratcheting tap handle included.

High speed steel end mill tool kits

Available thread sizes	Available end mill diameters
1/4-28	5/8 in., 1 in., 1 1/4 in.
10-32	5/8 in., 1 in.
M5x.8	5/8 in.
M6x1	1 in., 1 1/4 in.
M8x1.25	1 1/4 in.

Carbide tipped end mill tool kits

Available thread sizes	Available end mill diameters
1/4-28	5/8 in., 1 in., 1 1/4 in.
M8x1.25	1 1/4 in.



Backed by our Unconditional Lifetime Warranty!

CTC offers a wide array of 4-20 mA output solutions for industrial applications. CTC's standard 4-20 mA loop-powered vibration sensors are available with velocity as well as acceleration output measurement options. CTC's loop-powered sensor line also includes a dual output option, with both 4-20 mA output and dynamic output configurations in one sensor. Other options include 24 VDC powered transmitters that power standard IEPE accelerometers and convert the vibration to a powered 4-20 mA signal. These transmitters also offer a 4-20 mA output for temperature when coupled with CTC dual output vibration and temperature sensors.

Velocity & Acceleration

LP200 Series sensors for velocity and LP300 Series sensors for acceleration come in top or side exit connector, integral cable, and armored integral cable options. LP400 Series sensors for dual output come in top, integral, and armored integral exit options.

LP200
Velocity
output



TOP EXIT

LP300
Acceleration
output



TOP EXIT

LP400
Dual output



TOP EXIT



SIDE EXIT



SIDE EXIT



INTEGRAL OPTIONS



Backed by our Unconditional Lifetime Warranty!



SC300 SERIES

USB configurable,
dual channel vibration
plus temperature



SC900 SERIES

Class 1, Division 2
approved, 4-20 mA
vibration transmitters

Signal Conditioner Enclosures

CTC's Signal Conditioner Enclosures are turnkey solutions, which come fully populated with signal conditioners, power supply, and terminal blocks for sensor terminations. The signal conditioners are available pre-configured based on customer-specific requirements. Terminal blocks are provided for easy sensor terminations. These terminal blocks are pre-wired to the signal conditioners, and the outputs from the signal conditioners are wired to terminal blocks for integration into PLC/DCS systems.



XE151

1-12 channel
enclosure



MVR1000

1-4 channel
enclosure



XE550 SERIES

1-8 channel
enclosure with up
to 16 total IP based
outputs



Backed by our Unconditional Lifetime Warranty!

PROXIMITY PROBES

CTC offers a complete line of proximity probe systems designed and built to endure the harshest industrial environments. Proximity probes systems are available with probe tip sizes in FFV 5mm, 8mm, 11mm, and 25mm diameters. The variety of probe sizes offered allows accurate and precise machinery measurements for applications involving radial dynamic, axial rotor position, and thermal case expansion measurements.



PROBE TIP OPTIONS

FFV 5mm, 8mm, 11mm, 25mm

Standard and armor cable options available

Complete Your Prox Probe Assembly



DRIVERS



EXTENSION
CABLES

Proximity Probe Accessories



ENCLOSURES

Fiberglass and stainless steel enclosures
1-6 channels
Powered and 4-20 mA options available

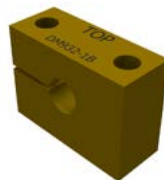

MOUNTING BLOCKS



REVERSE MOUNT
HOUSING



Backed by our Best-in-Class Warranty!

Wireless Vibration Transmitter



WA102-1A

Bluetooth® 5 capable.

Compatible with AC312/AC314 low power accelerometers.

Captures a dynamic signal at a user specified sampling rate for a user specified sample time.

Estimated 4+ years of battery life when taking 2 or fewer scheduled measurements daily.

User configurable 1 - 40ks/sec, F-max = 15,652 Hz ((40ks/s) / 2.56).

Completely customizable monitoring software — No subscription required.

WA100-TAB

Microsoft - Surface Go 2

10.5 in. Touch Screen

Keyboard and stylus not included

Processor Model: Intel Pentium Gold 4425Y

System RAM: 4GB

Storage capacity: 64GB

Micro SD Card slot available for expandable storage



Coming in 2021

WA100-AP

Bluetooth 5 wireless transmission

1000 Mbps Wired Ethernet connection to any private network

Three connection speeds: 2 Mbps, 1 Mbps, 125 kbps (Long Range Mode)

150 ft range with Line of Sight, 600 ft when operating in Long Range Mode

On-board 4 GB storage for offline readings until database connection is restored

Device is programmable through the free CTC Wireless Application.



Backed by our Best-in-Class Warranty!



VIBRATION ANALYSIS HARDWARE



PROTECTION & RELIABILITY INSTRUMENTS

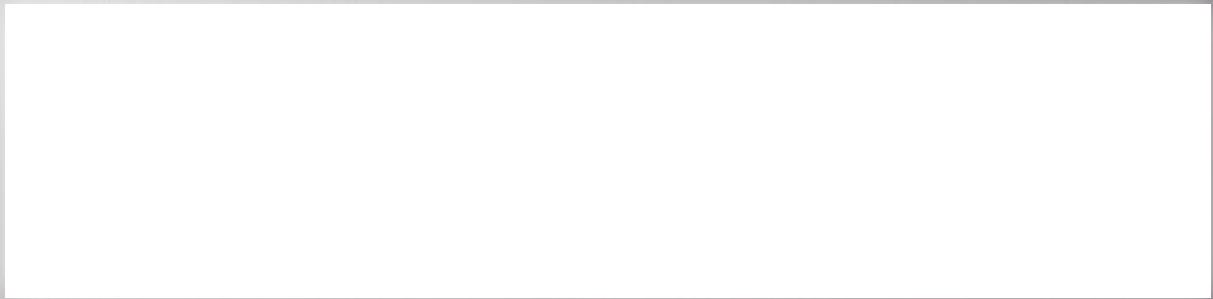

BACKED BY OUR UNCONDITIONAL
LIFETIME WARRANTY